

REUSABLE AND MODULAR FORMWORK IN ABS FOR WALLS



geopanel

the universal panel for walls



- LIGHT
- PRACTICAL
- REUSABLE





GEPANEL VISION

CONSTRUCTION and RESPECT: This is the vision which characterizes the work of Geoplast. To build buildings respecting the environment. Beginning from the choice of the raw materials. Our plastic formwork perfectly embodies this principle.

THE ANNUAL WORLD CONSUMPTION OF WOOD IS EQUAL TO 1,5 BILLION M³, OF WHICH 55% IS USED IN CONSTRUCTION

After having exhausted the resources of timber in Southeast Asia and Central Africa, logging is causing the deforestation of the Amazon Rainforest, which is considered the green lungs of our Planet.

In the last three decades 55 million hectares of rainforest have been cleared, an area corresponding to the territory of France.

This is why we decided to make our contribution creating a line of formwork in plastics, a recyclable material that is the only sustainable alternative to wood and cardboard.

We have made them with special attention to their weight to reduce the amount of energy required for their handling: this is yet another form of respect.

Geoplast S.p.A. in Green Building Council Italia,
The Network of Green Building.





GEOPANEL

FORMWORK IN TECHNOPOLYMER

GEOPANEL is an easy and intuitive system of modular formwork in technopolymer used to build walls, foundations and columns in concrete.

The wide range makes it easy to produce structures of any size and shape.



Why ABS

(Acrylonitrile Butadiene Styrene)

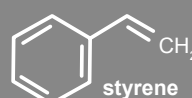
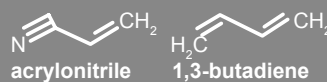

High mechanical strength

Shock resistance

Thermal stability
 (-30°C / +70°C; -22°F / +158°F)

Very high surface quality

Recyclable material

GEO PANEL ADVANTAGES

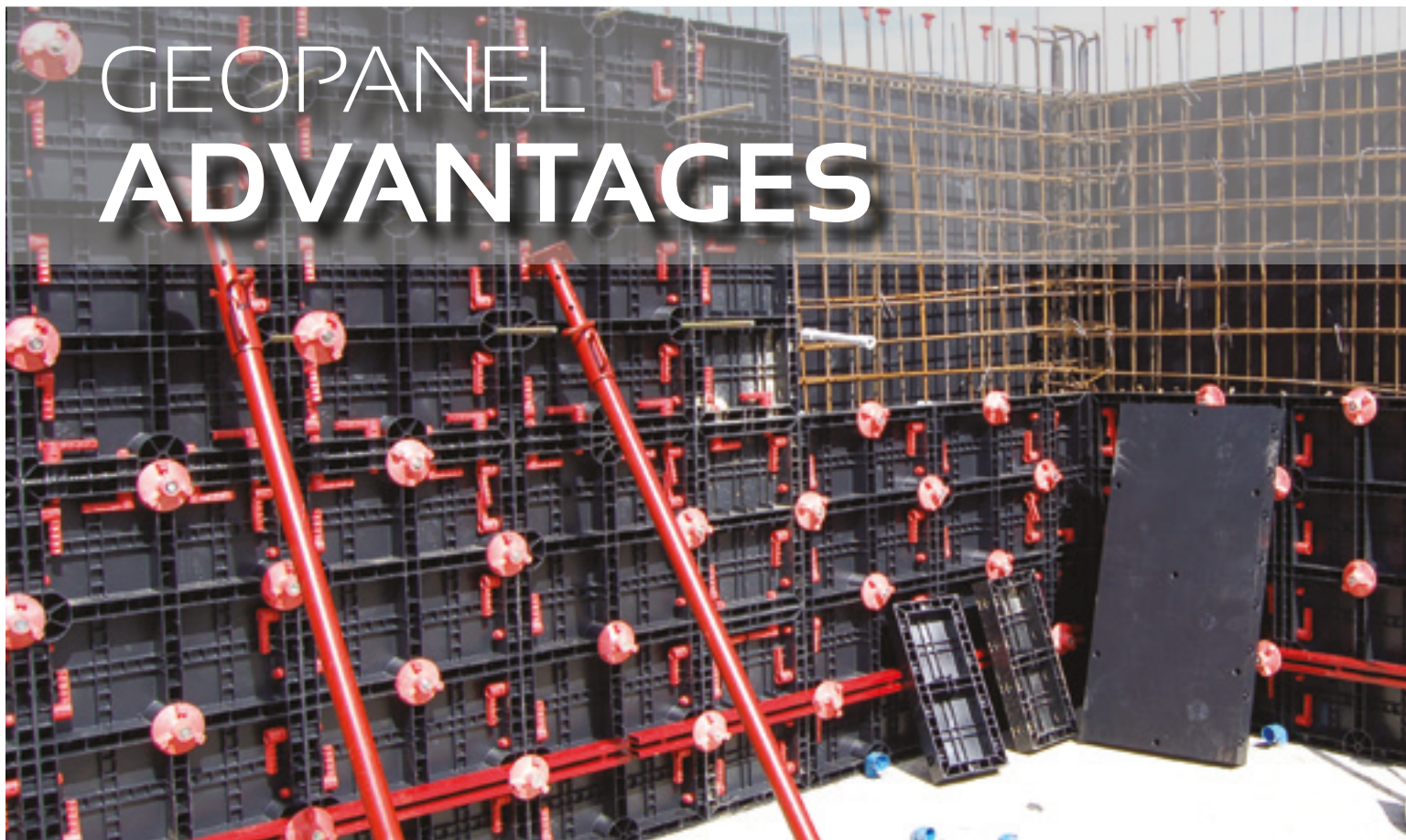

The only light, reusable and modular system for concrete wall production

light



Weighting just 11 kg, **GEO PANEL** can be handled quickly on site without having to use cranes or other mechanical lifting devices

fast



Light and easy to assemble, it can be installed and handled by a single person

modular



All elements are 600 mm long and only the elements necessary for the pour are used

reusable



GEO PANEL is cost effective as it can be reused **more than 100 times** when properly used and maintained

dismantling



Concrete does not stick to plastic: dismantling is extremely easy, the forms can be cleansed using just a little water, without any need of detergent

storage



GEO PANEL can be safely and conveniently stored even in damp places

GEPANEL 120 x 60

THE MAIN PANEL

Up to 60 KN/m² fresh concrete pressure

REUSABLE

just
11 Kg

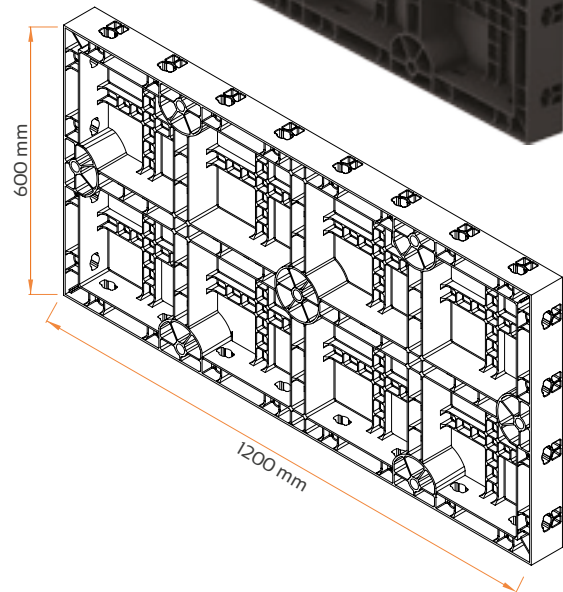
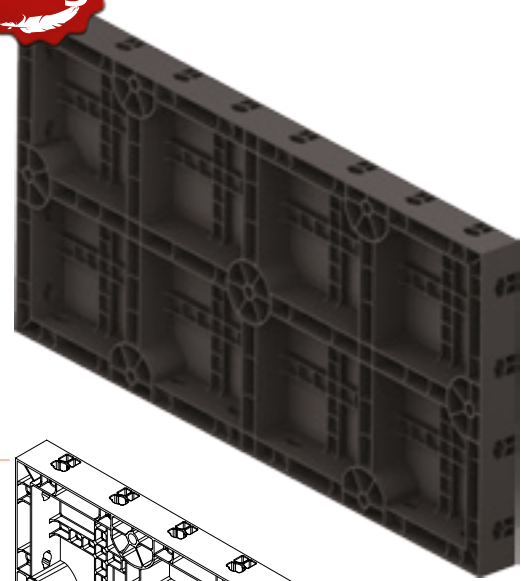

GEPANEL MATERIAL

Acrylonitrile Butadiene Styrene	ABS
Coefficient of thermal expansion	0,05 mm/m/°C

SIZE

LENGTH	1200 mm (actual size 1210 mm)
HEIGHT	600 mm (actual size 605 mm)
THICKNESS	80,00 mm

The handle

The standard fixing item for all Geoplast Formwork

Light and intuitive

Firmly locks with a simple 90 degree turn

Strength (guaranteed by specially engineered materials)

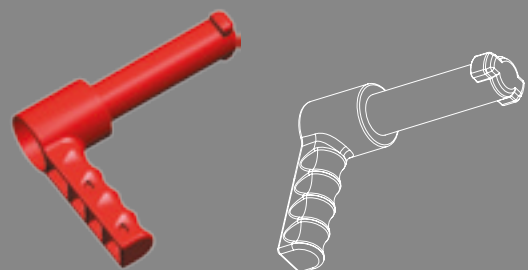

HANDLE MATERIAL: POLYAMIDE - COEFFICIENT OF THERMAL EXPANSION 7-10 (1/K 10⁻⁵)

Items and accessories

DIMENSIONAL TABLES

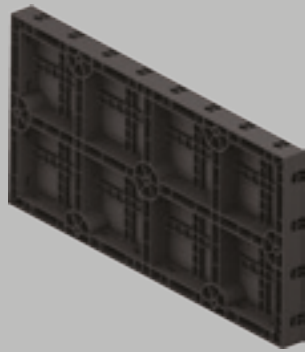

**GEOPANEL
120 x 60 x 8**

actual size (mm)

1210 x 605 x 80

material

ABS

weight (kg)

11

package size (mm)

750 x 1210 x H2580

No. pieces per pallet

38

No. handles

12



**GEOPANEL
20 x 60 x 8**

202 x 605 x 80

ABS

2,38

770 x 1210 x H2350

204

5



**GEOPANEL
25 x 60 x 8**

252 x 605 x 80

ABS

2,62

770 x 1210 x H2400

166

5



**GEOPANEL
30 x 60 x 8**

actual size (mm)

303 x 605 x 80

material

ABS

weight (kg)

2,94

package size (mm)

770 x 1210 x H2400

No. pieces per pallet

140

No. handles

5



**GEOPANEL
*35 x 60 x 8**

353 x 605 x 80

ABS

3,36

750 x 1210 x H2350

118

6



**GEOPANEL
40 x 60 x 8**

404 x 605 x 80

ABS

3,70

770 x 1210 x H2400

104

6



**GEOPANEL
INNER CORNER**

303 x 605 x 80

ABS

4,03

810 x 1210 x H2400

128

5



**GEOPANEL
OUTER CORNER**

252 x 605 x 80

ABS

3,12

800 x 1210 x H2300

130

5



**GEOPANEL WP
18-21-27**

100 x 605 x 80

ABS

1,5

800 x 1200 x H2450

450

4

actual size (mm)

material

weight (kg)

package size (mm)

No. pieces per pallet

No. handles



**GEOPANEL CL
20 - 25 - 30**

460 x 605 x 80

ABS

5,25

750 x 1200 x H2500

91

6



**GEOPANEL CL
35 - 40 - 45**

610 x 605 x 80

ABS

6,28

750 x 1200 x H2550

76

7



HANDLE

NYLON

0,1

200 pcs. (bag)

5000

actual size (mm)

material

weight (kg)

package size (mm)

No. pieces per pallet

No. handles

ACCESSORIES



CAP 43

WEIGHT (kg)

0,014

MATERIAL

ABS



CAP 25

0,101

PE HD



**ANCHOR NUT
for tie rods**

0,370

NYLON



LIFTING HOOK

WEIGHT (kg)

2,13

MATERIAL

STEEL



**BRACE
CONNECTOR**

0,30

STEEL



**CONNECTOR
PLATE**

0,85

STEEL



**SPACER
15/20/25/30/35/40**

WEIGHT (kg)

0,035 -> 0,070

MATERIAL

PE HD



**TIE ROD
30/75/100/150**

0,430 -> 2,150

STEEL



**ALIGNMENT BAR
500/750/1000/1500/2000**

WEIGHT (kg)

2,60 -> 9,50

MATERIAL

STEEL

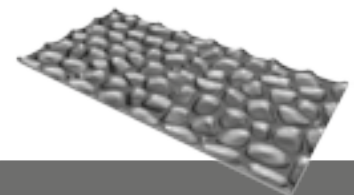

**GEO PANEL
ART**

4,46

ABS

GEOPANEL INSTALLATION GUIDE

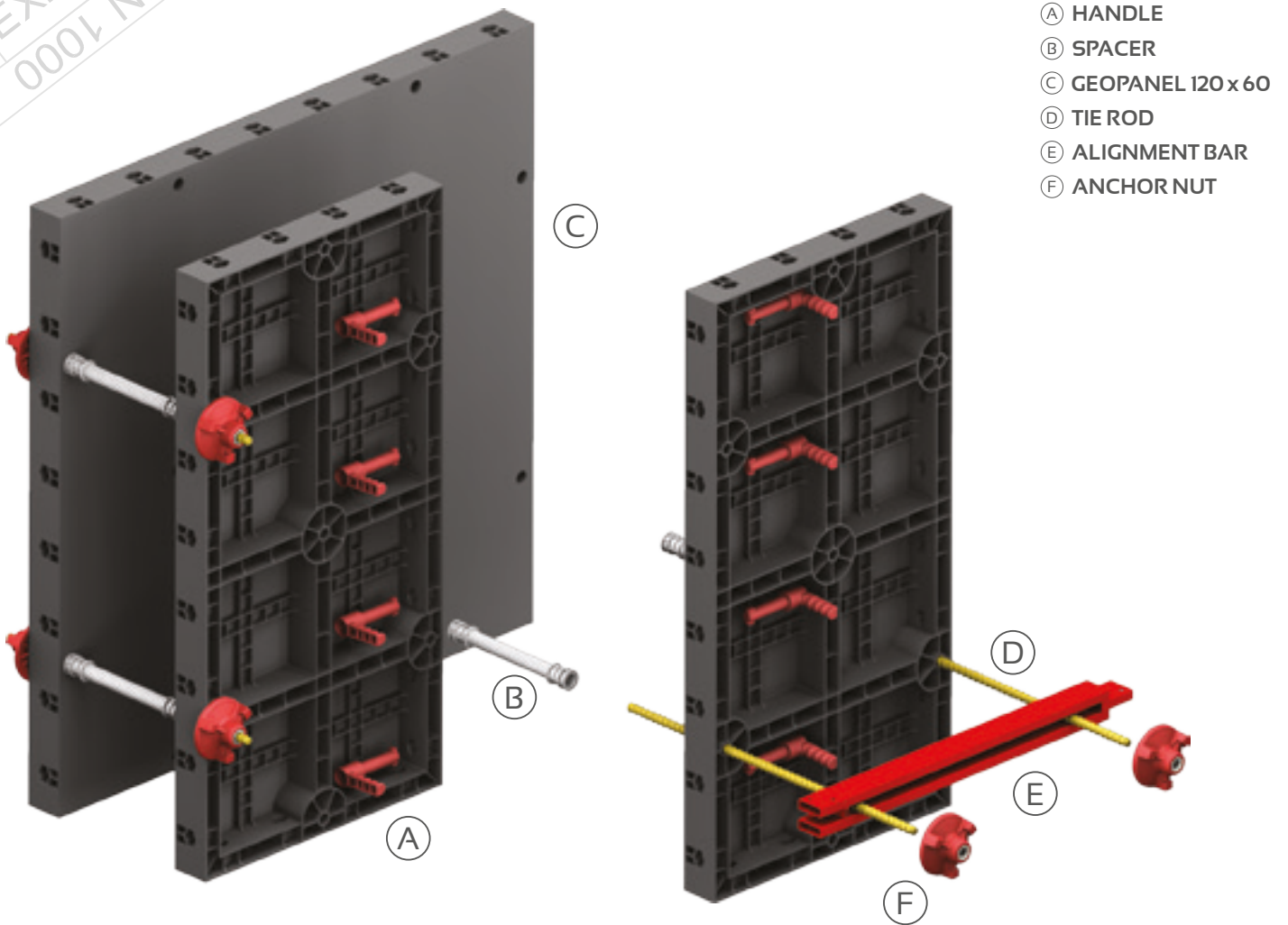

Handle locking

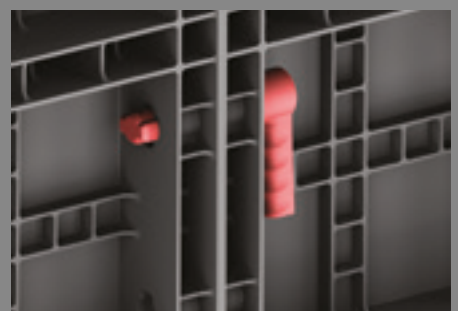
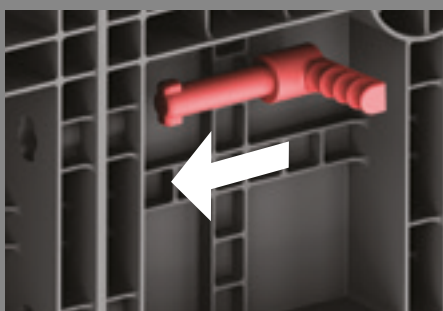

CORNER CONFIGURATION

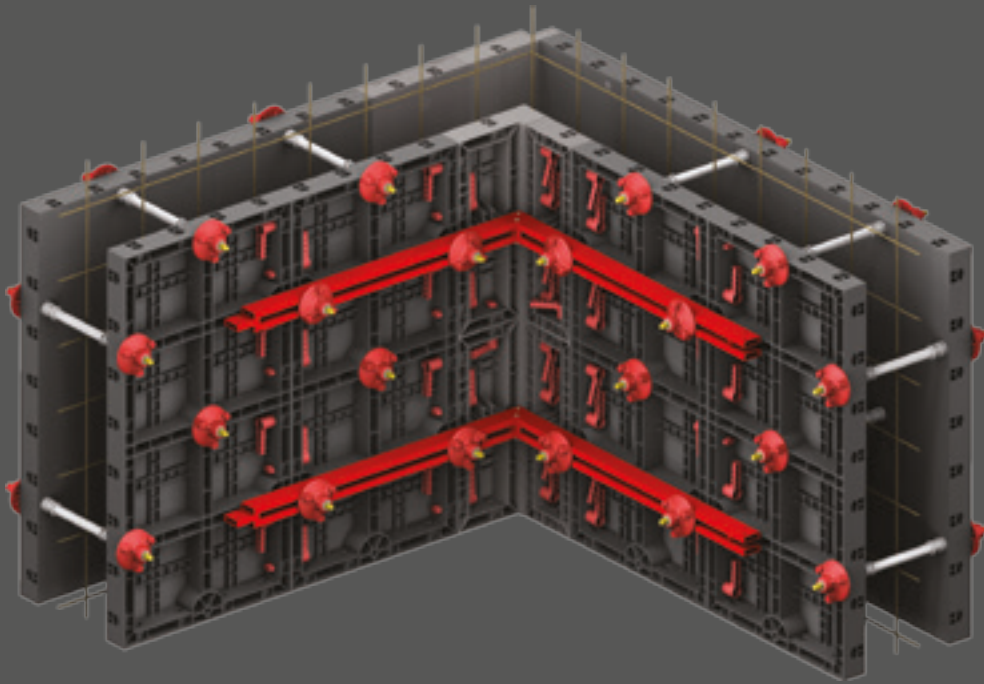

THICKNESS 100 mm

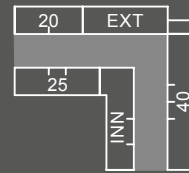

THICKNESS 150 mm

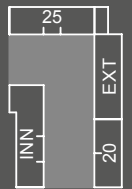

THICKNESS 200 mm

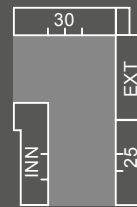

THICKNESS 250 mm

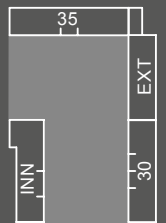

THICKNESS 300 mm

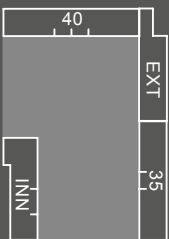

THICKNESS 350 mm

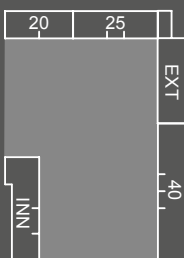

THICKNESS 400 mm

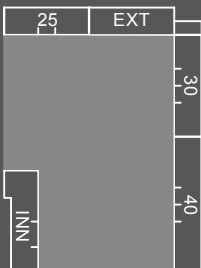

THICKNESS 450 mm

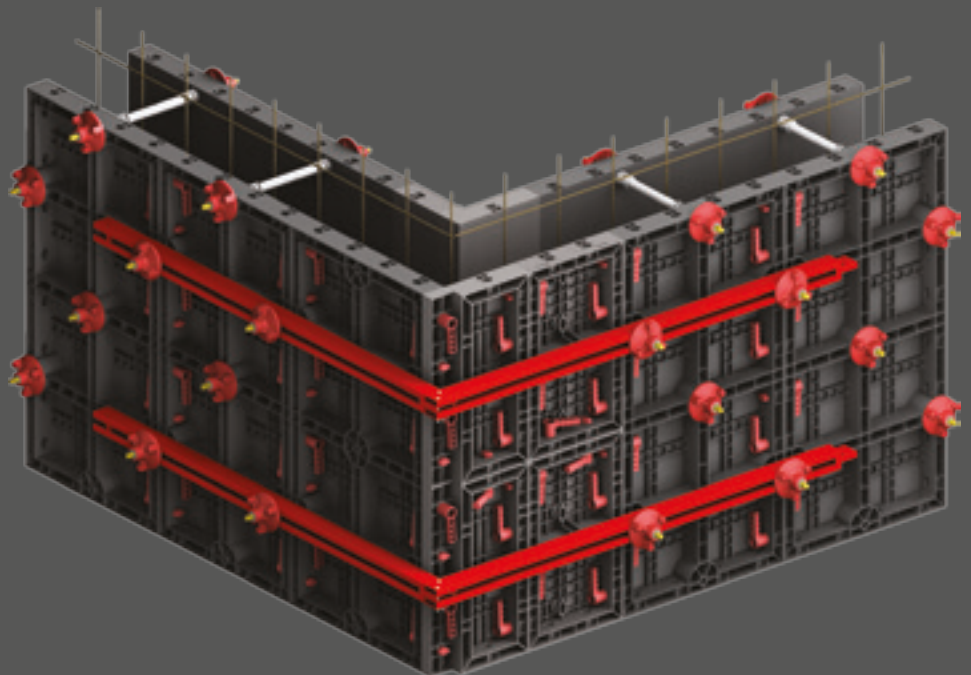
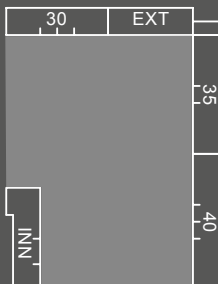

T-INTERSECTIONS



THICKNESS 100 mm



THICKNESS 150 mm

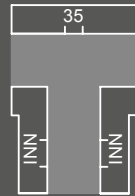

THICKNESS 200 mm

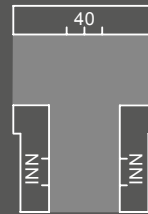

THICKNESS 250 mm

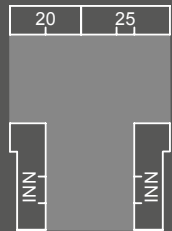

THICKNESS 300 mm

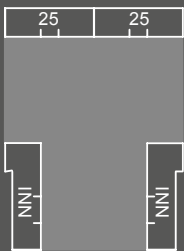

THICKNESS 350 mm

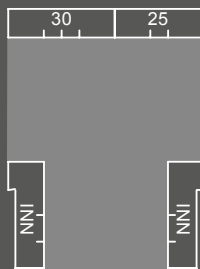

THICKNESS 400 mm

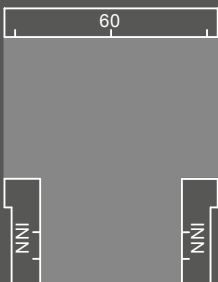

THICKNESS 450 mm

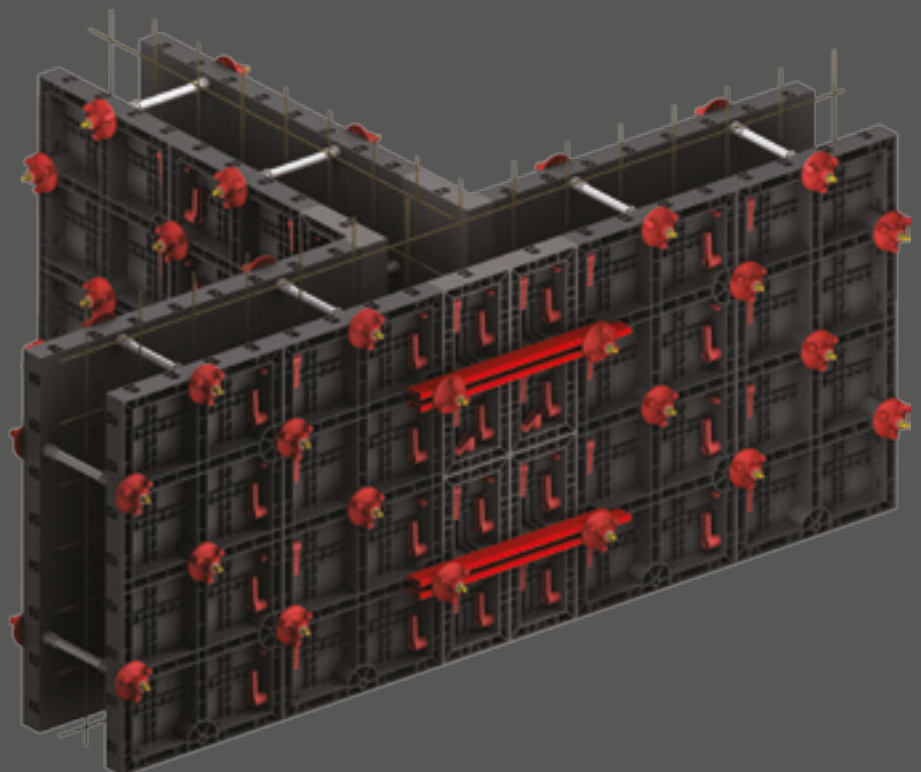
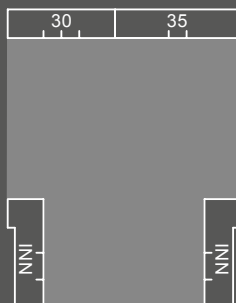

GEO PANEL FORMWORK LAYOUT

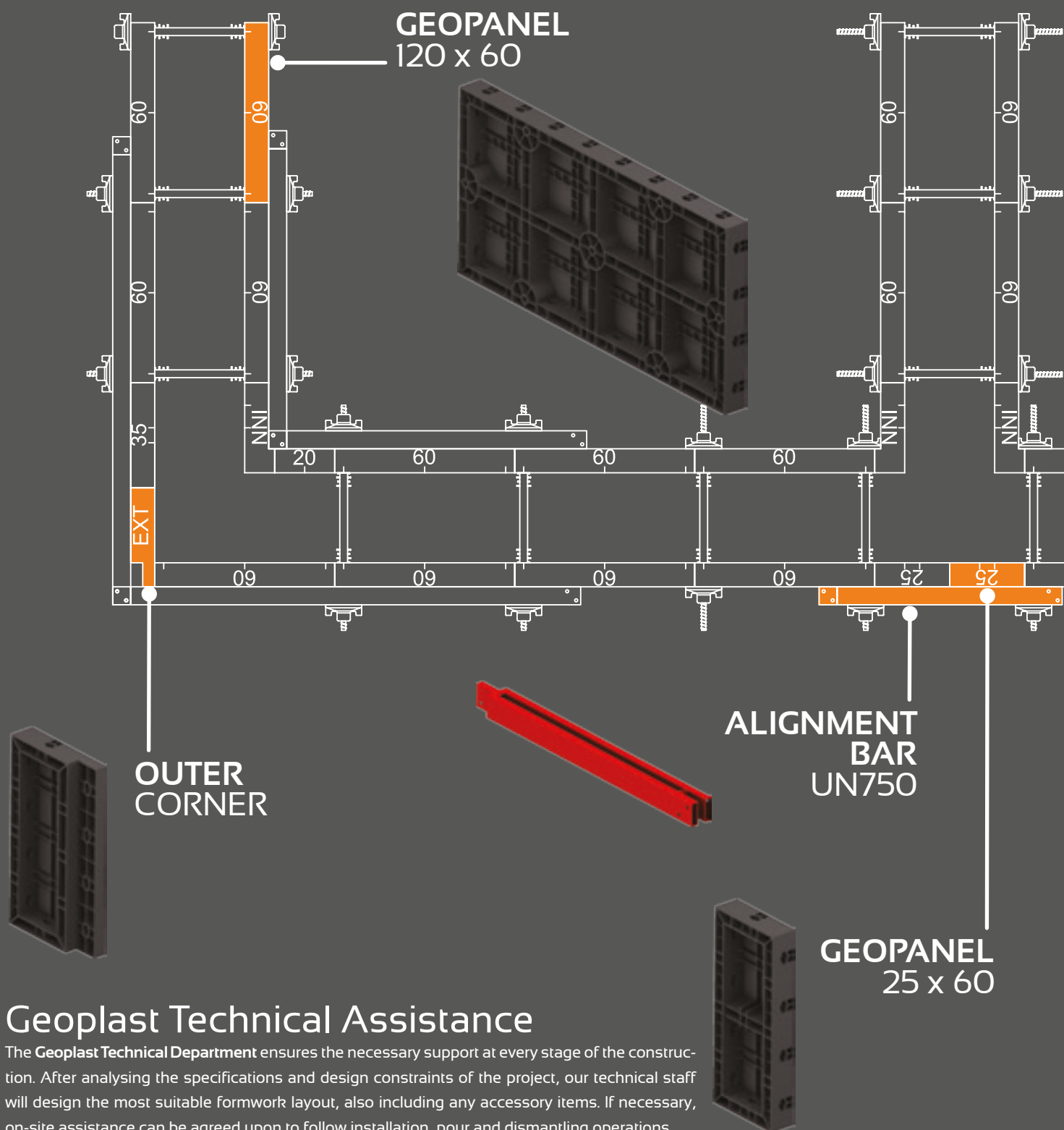

Geoplast Technical Assistance

The **Geoplast Technical Department** ensures the necessary support at every stage of the construction. After analysing the specifications and design constraints of the project, our technical staff will design the most suitable formwork layout, also including any accessory items. If necessary, on-site assistance can be agreed upon to follow installation, pour and dismantling operations.

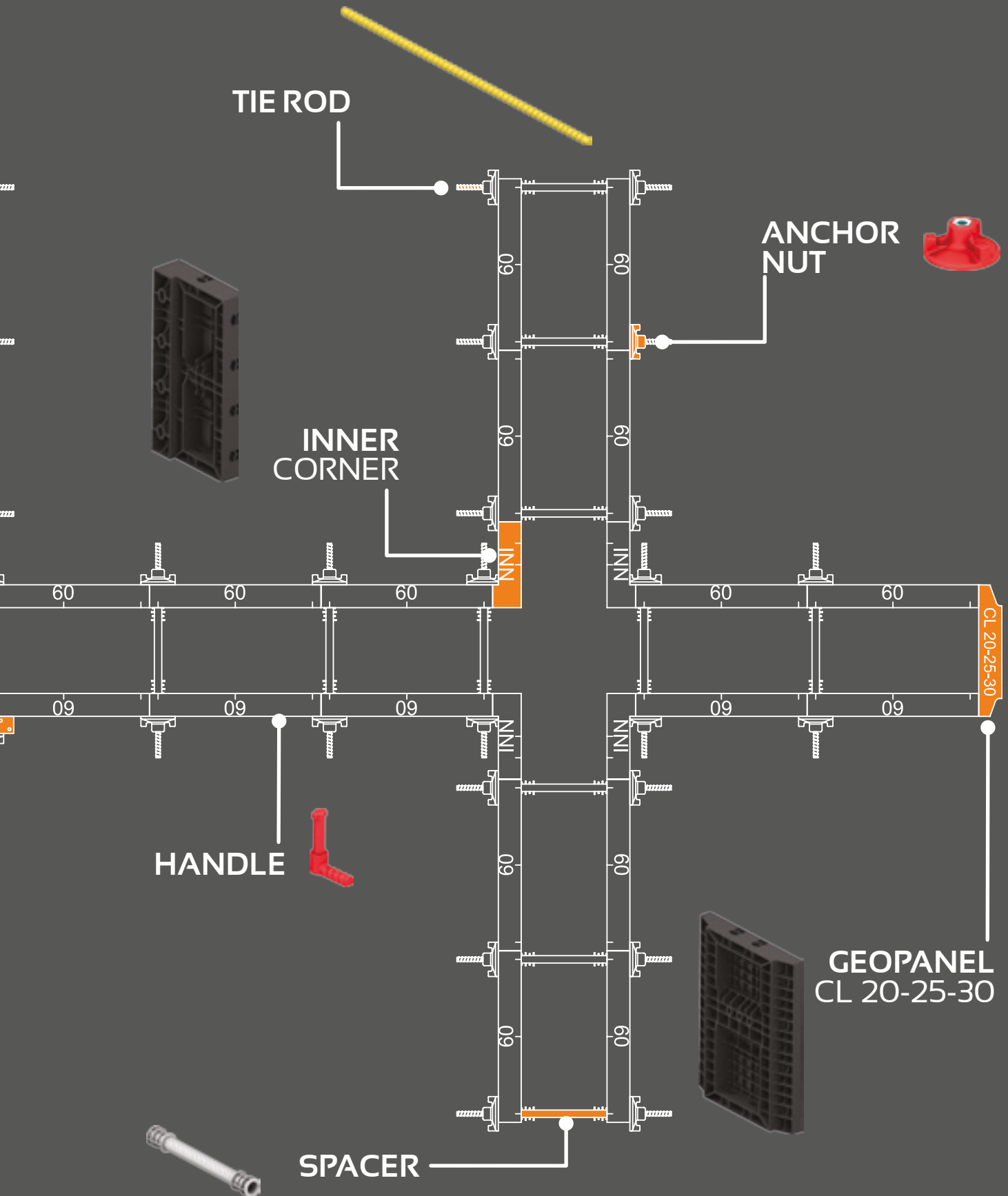

The reusable panel for concrete walls

GEOPANEL WALLS



Geopanel System

GEOPANEL allows the production of walls of any thickness and height. The wide range of items and sizes meet any requirements. As the panels are made of plastic material (ABS), the concrete finish

is extremely smooth and uniform, ensuring high quality. The panels are handled effortlessly as they are extremely light (max. 11 kg) making production fast even with a single worker.



www.geoplast.it

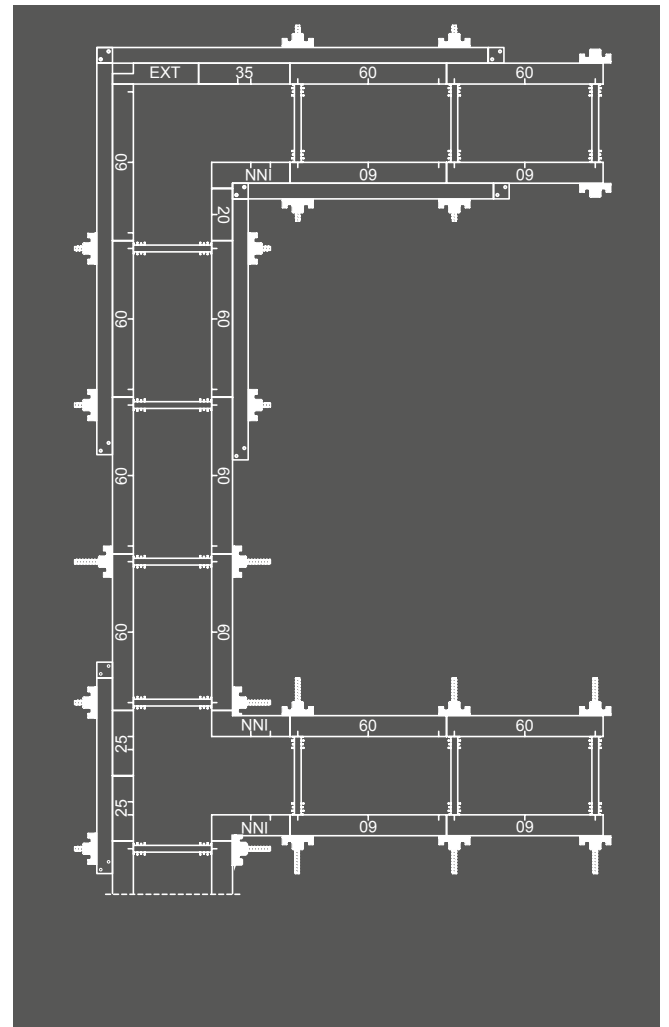



System suitable for use at high ambient temperature
Easy to handle on site, even without using cranes or other lifting devices
Excellent surface quality



GEOSKY SLABS

Reusable ABS formwork for concrete slabs



Geopanel goes flat out

GEOSKY is a reusable roof slab formwork system which uses elements and a series of plastic supporting beams. The panels ensure a very good and consistent concrete surface quality. The plastic beams are designed to allow strip-

ping of the concrete slab shortly after the pour, dramatically decreasing the turn-around time of the formwork thus allowing a much tighter pour schedule. The whole system rests on standard H20 timber beam.

ADVANTAGES

Advanced
dismantling
Modular
Safe



COMPLETE GEOSKY SYSTEM

Thanks to the access from below, **GEOSKY** allows safer working conditions, avoiding fall hazard from heights, during both set-up and dismantling.

GEOSKY is suitable for the production of roof slabs for commercial, industrial and residential buildings.

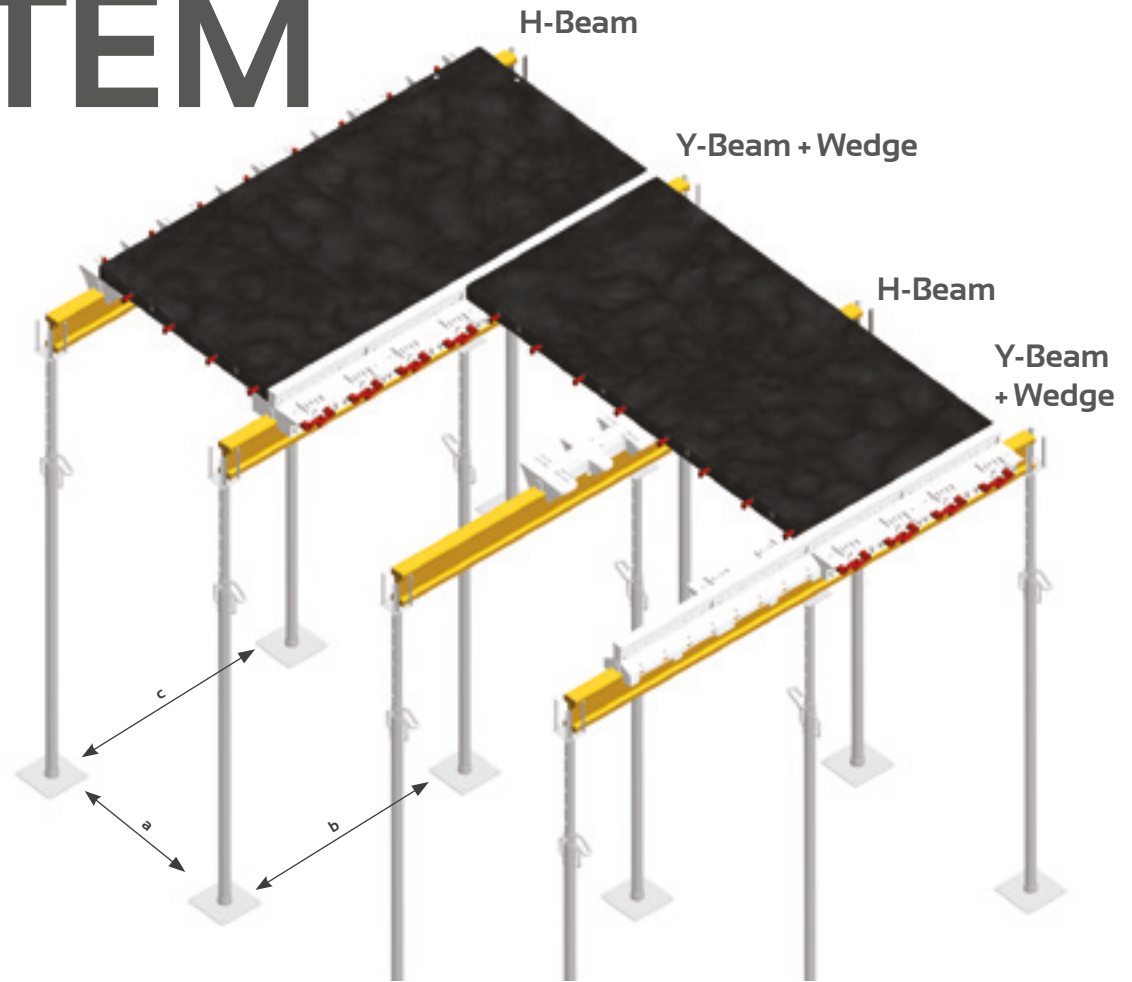

System items and shoring criteria



Y-BEAM

Lodges onto standard H20 timber beams with WEDGES which allow the advanced dismantling of the formwork panels



WEDGE

This item allows the advanced dismantling. When detached from the Y-beam makes the removal of the panels possible



H-BEAM

Panel support element, it is one of the first elements to be removed during dismantling



HS-BEAM

Panel support element. Useful replacement of the HS-Beam in some formwork configuration.



	SLAB THICKNESS			
	Up to 20 cm	Up to 25 cm	Up to 35 cm	Up to 40 cm
Prop spacing H20 Beam (a)	125 cm	125 cm	60 cm	60 cm
Props for Y-Beam + Wedge (b)	150 cm	100 cm	150 cm	100 cm
Props for H-Beam (c)	150 cm	150 cm	150 cm	150 cm

ELEVATOR SHAFTS STAIRWELLS



Geopanel for technical rooms

- Reduced building time
- No lifting devices
- Numerous combinations

GEOPANEL system is ideal for the construction of stairwells and elevator shafts. The lightness and easier handling of the panels allows carpenters to speed up the setup and dismantling, giving them

the possibility to repeat the operations quickly in the various floors of the building. The accessories included in the system make it easy to form corners and wall intersections without needing fill-in elements.



www.geoplast.it

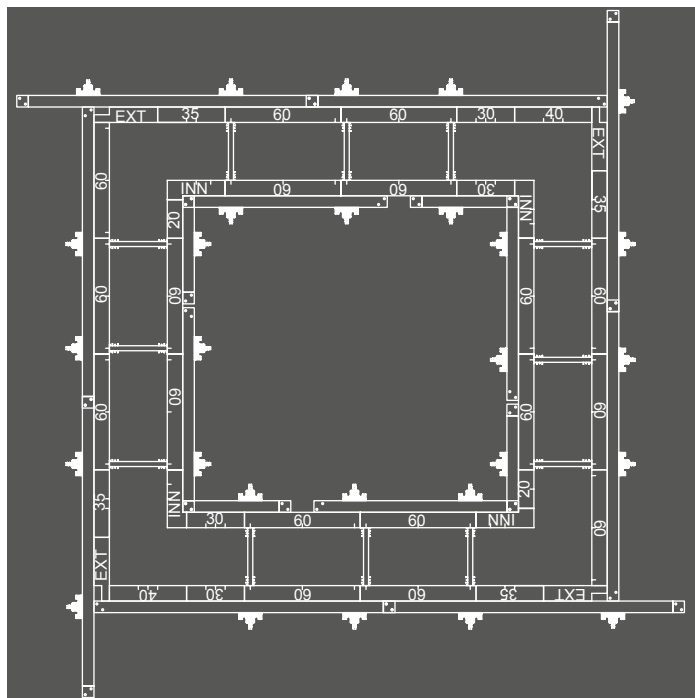



RING BEAMS, LINTELS & INFILL WALLS

Winner in renovation

GEOPANEL is light and of manageable size. These features make it the ideal formwork system for use inside buildings and in other areas of a construction site that are inaccessible to lifting devices. The modular panels will adapt to any size and shape and are ideal for lintels, ring beams and infill walls.

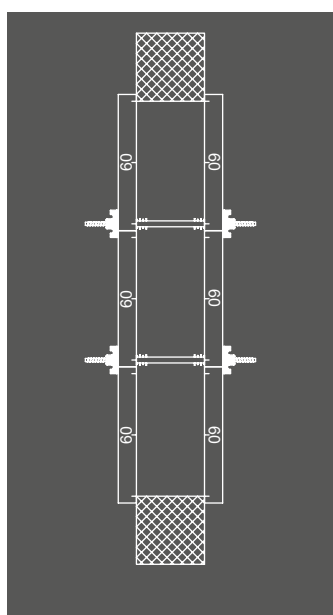

GEO-PANEL POOLS



Reinforced concrete swimming pools

The versatility of **GEO-PANEL** formwork is well suited to the construction of swimming pools. Infinite custom variations of size and shape can be produced using the large range of panels and accessories. **GEO-PANEL** will work perfectly with the complex equipment of the pool. It is also possible to create sloping floors, thus creating diving areas and relax zones.



www.geoplast.it

GP73/S

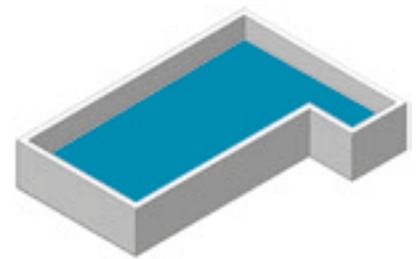

GP84/S

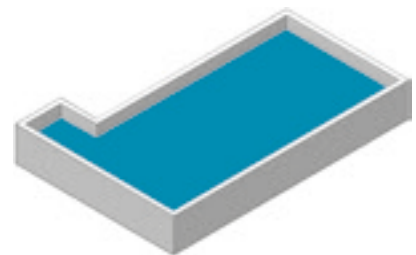

GP126/S

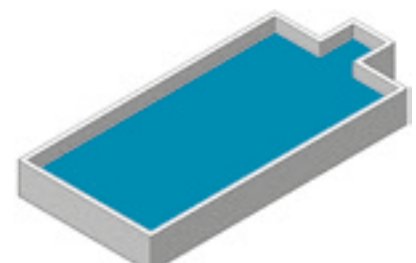



GEOPANEL SHEAR WALLS

Shear walls

Shear walls are built to counter the effects of lateral load such as wind or earthquakes acting on a structure. Easy to handle, **GEOPANEL** system is excellently suited for this type of application.

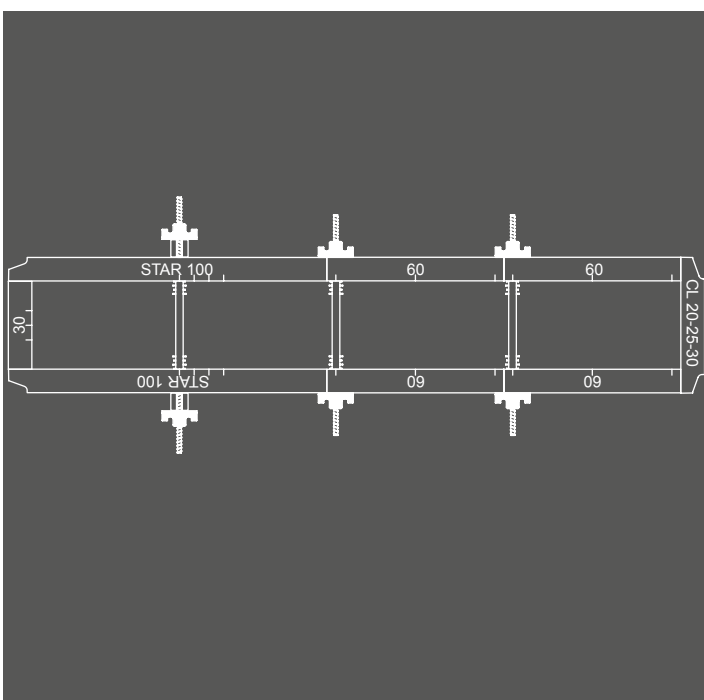

GEO PANEL & GEO PANEL STAR

FOCUS
GEO PANEL
35X60

Geoplast Formwork Versatility

GEO PANEL panels are compatible with the **GEO PANEL STAR** range. **GEO PLAST** system's modularity allows the construction of particu-

lar configurations such as columns integrated in concrete walls. It is thus possible to achieve this technical solution with a single pour.

Thanks to the new **GEO-PANEL 35** panel, it is possible to expand the range of the configura-

tions, building square (150 x 150 mm or 120 x 120 mm) and rectangular columns (150 x 120 mm).

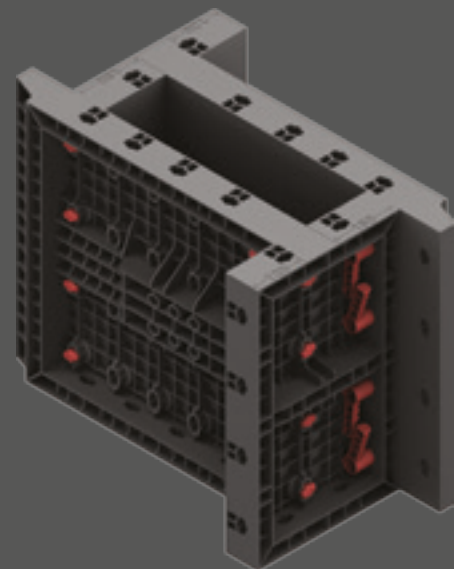
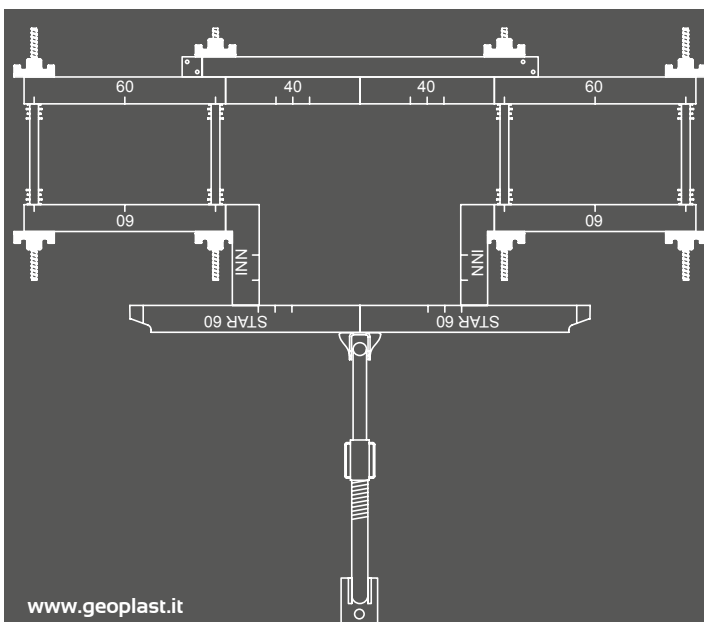



Large columns

In combination with **GEO-PANEL STAR** elements, **GEO-PANEL** is used to form large columns. The two panel systems work very well together

as they share the same module. The standard **GEOPLAST** fixing handle makes the installation on site extremely intuitive, fast and safe.

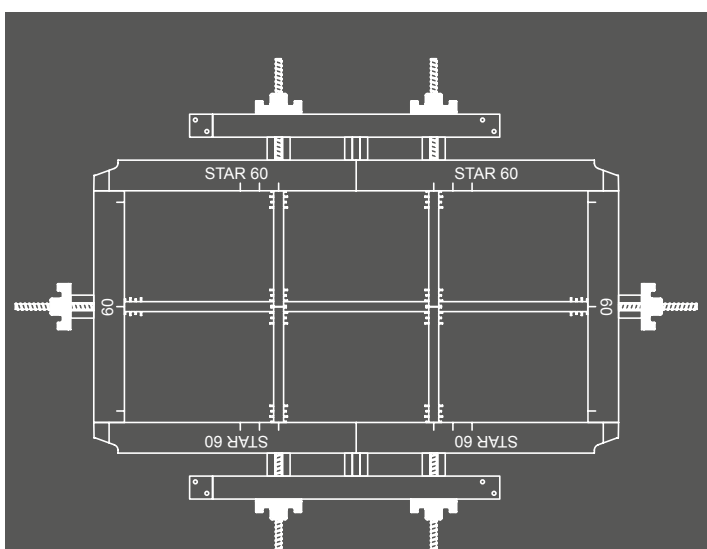

OVAL COLUMNS



Geopanel & Geotub $\varnothing 25/30/35/40/45/50/60$

The ideal solution for car parks

Most of the **GEOPLAST** formwork panels share the same module and different systems are compatible with one another. **GEOPANEL** and the **GEOTUB** circular column formwork work together very efficiently to produce

elliptic columns. This is a very useful tool for the production of elliptic columns in multi-storey car-parks, much appreciated for their slender looks and the better maneuvering space given to vehicles.

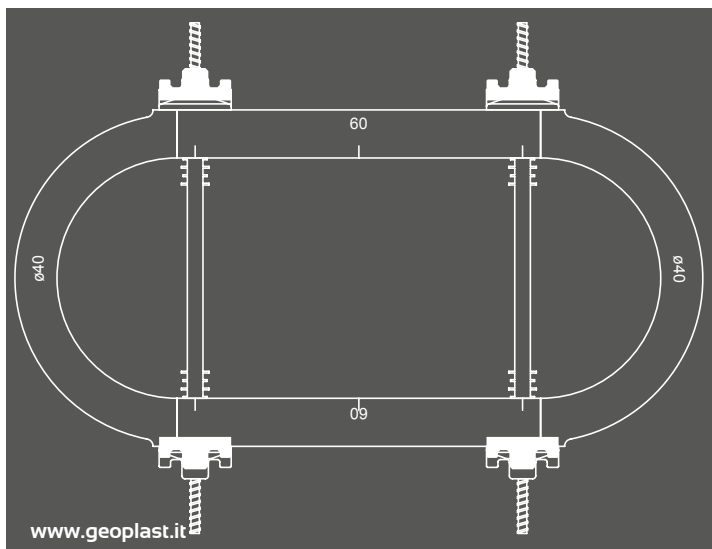

GEOPANEL HOUSING SYSTEM



High productivity concrete houses

Governments, builders and individuals in developing countries are facing an exponential growth in demand for housing: it is therefore increasingly urgent to find a solution to build houses quickly and cost-effectively. Thanks to its lightness and maneuverability, **GEOPANEL** is the ideal solution to build customized buildings as social houses and terraced houses in a short

time and at low costs. Not requiring the use of mechanical devices to handle it, **GEOPANEL** can be used and installed in every plot of land, even in the most inaccessible ones. To complete the construction of housing with a high value for money, we recommend **GEOPLAST MODULO** system to ventilate the foundations.

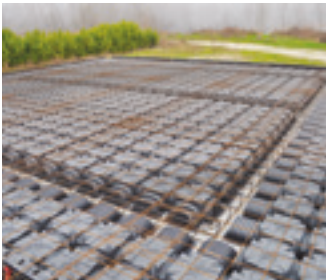



GEO PANEL ART

Panels for textured walls

This is a reusable and modular high-resistance formwork panel used to create textured reinforced concrete walls. Made of ABS, **GEO PANEL ART** is used in combination with **GEO-PANEL**. The two elements are assembled to create a high-productivity mold for the production of textured concrete. The con-

crete surface receives the decoration from the panels and the result is a wall ready to be painted or further decorated in order to achieve an even more realistic and creative look. Replicating the pebbles of a mountain stream, the River Stone panel is irregularly shaped to obtain a very "real looking" result.

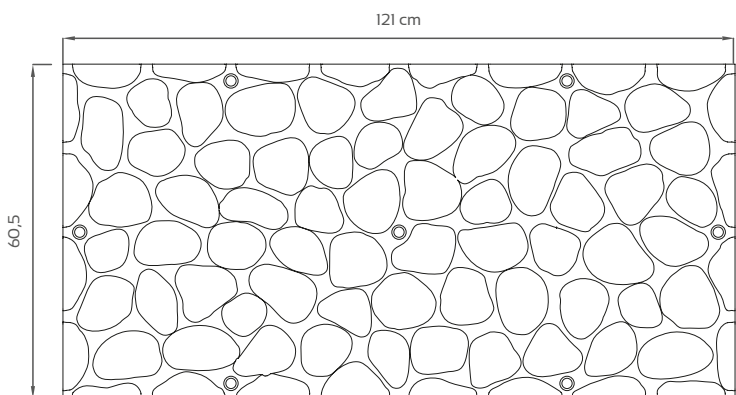
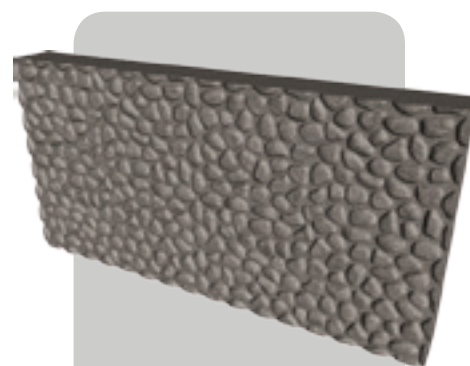

www.geoplast.it

GEO PANEL ART

actual size (mm)	1210 x 605 x 25
material	ABS
weight (kg)	4,46
package size (mm)	1200 x 750 x H2020
No. pcs.	80

GEOPANEL ART ADVANTAGES

Simple and easy to use, **GEOPANEL ART** helps you save time and money. Results are immediate and no further action is needed on the decorated wall. Light and easy to handle, **GEOPANEL ART** is a product with an excellent benefit-cost ratio.

- Immediate result
- High quality concrete finish
- Reusable
- Customizable

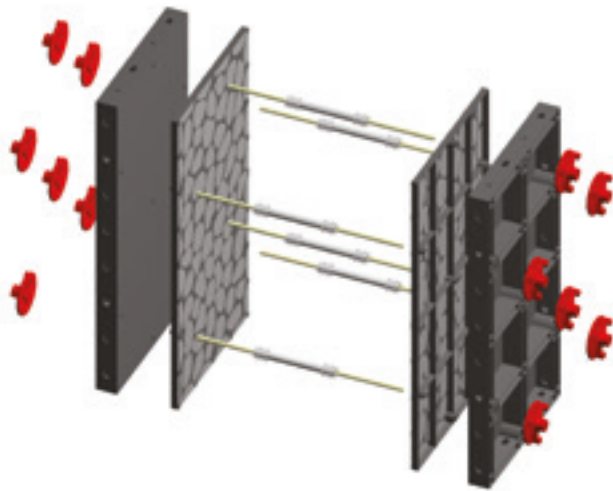

How to assemble

GEOPANEL ART panels are clipped onto the **GEOPANEL** 120x60 cm panels using the tie rods holes as latching points. Standard tie rods and anchor nuts are used to hold them tightly in position. Plastic spaces sleeves are inserted between the panels and are lost after the concrete pour. The pan-

els can be assembled in any combination without interrupting the decorative texture. **GEOPANEL ART** is easy to handle and can be simply dismantled from **GEOPANEL** panels after use. The forms can be then cleaned just with water.



ON REQUEST

Woodline



Prun

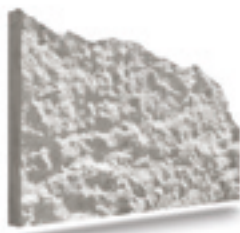

Wall



Line



GEO PANEL TECHNICAL GUIDELINES

A) SHORING

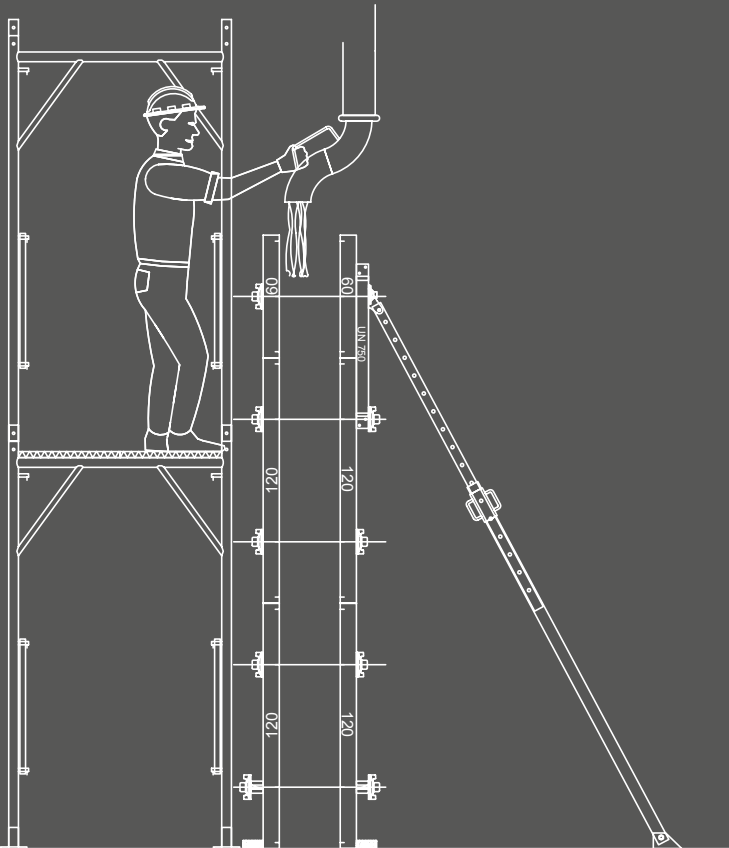

The shoring is performed using a steel bracket to connect push-pull props to the formwork. The brackets are available in various sizes to suit any commercially available props.

B) GROUND ANCHORING

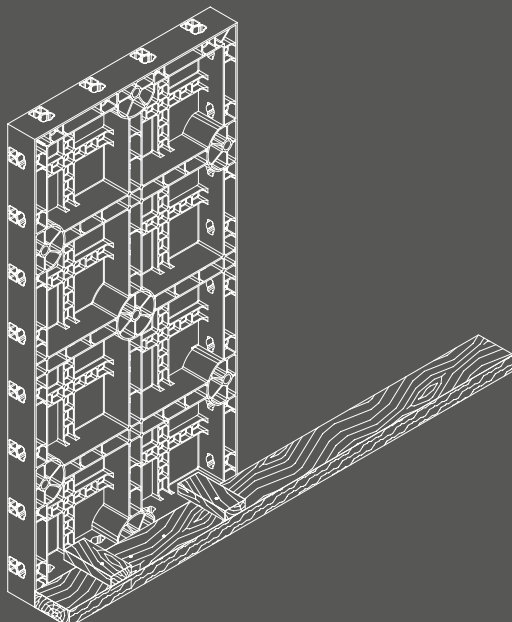

Anchoring to the ground to stabilise the formwork is simply done using timber.

OPERATION AND MAINTENANCE REQUIREMENTS

POUR

Only immersion concrete vibrators are allowed. ABS formworks are not fireproof, so do not place them close to hot objects or open flame.

HANDLING

Use lifting clamp to lift the already assembled panels with a crane. Before lifting make sure that the lifting cables have an uniform draft.

PANEL CLEANSING

After every use, cleanse the panels with water (preferably with a pressure washer). Any deposit of concrete should be removed with a spatula or a wire brush.

RELEASING AGENT

As long as the contact surface of the panels shows no signs of wear, no releasing agent is required.

STORAGE

In order to facilitate the handling and lifting of the panels and all accessories, store them on pallets or battens to keep them off the ground. Although the product does not suffer weathering, it is preferable to store the panels in a dry place away from direct sunlight.

RATE OF RISE DIAGRAM

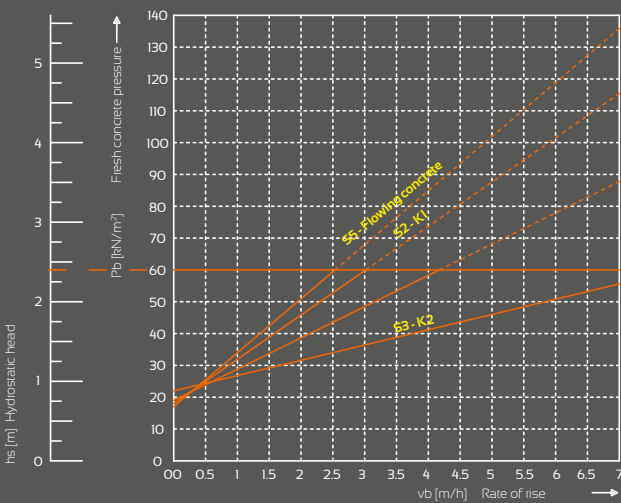

CONSISTENCY CLASS	UNI EN 206:2006		DIN 18218	
	CLASSIFICATION	SLUMP	CLASSIFICATION	SPREADING
Wet	S1	10 ÷ 40 mm		
Stiff	S2	50 ÷ 90 mm	F1 (K1)	≤ 34 cm
Plastic	S3	100 ÷ 150 mm	F2 (K2)	35 ÷ 41 cm
Soft	S4	160 ÷ 210 mm	F3 (K3)	42 ÷ 48 cm
Flowing	S5	≥ 220 mm	F4 (Flowing)	49 ÷ 55 cm

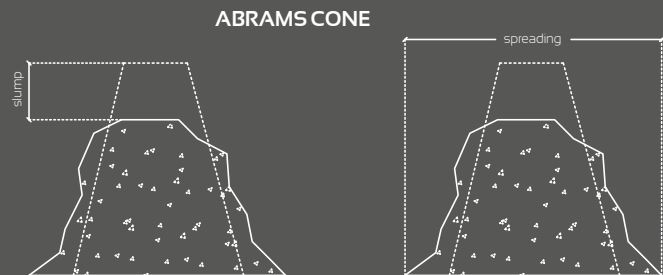

SAFETY REQUIREMENTS

The operations of positioning, assembling, dismantling, plumbing, handling and cleaning of **GEOPANEL** products, as well as the pouring of the concrete, must be carried out by competent and properly trained personal or under supervision of the site manager or a Technician of Geoplast S.p.A., who must ensure that:

- All above mentioned operations are carried out properly,
- Every person working with the formworks is equipped with suitable tools and personal protective equipment to perform all necessary actions in full compliance of the safety standards,
- All panels and the supplied accessories are checked before use, discarding those which should not meet the minimum standard of reliability and safety because of the presence of any breakage and/or deformation,
- The formwork is installed on a perfectly flat surface, so as to work safely and ensure a perfect shoring and plumbing,
- All connection, alignment and plumb accessories of the formworks are properly tightened and secured to the ground before starting the pour.

Geoplast S.p.A. disclaims any liability or responsibility arising from improper use of **GEOPANEL** formwork. Any assembly of molds and/or use of accessories otherwise described in these guidelines must first be approved by Geoplast S.p.A.



GEOPLAST S.p.A.

35010 Grantorto PD - Italia - Via Martiri della Libertà, 6/8

tel +39 049 9490289 - fax +39 049 9494028

e-mail: geoplast@geoplast.it - www.geoplast.it

